

PRE-ASSEMBLED BLAST ROOMS

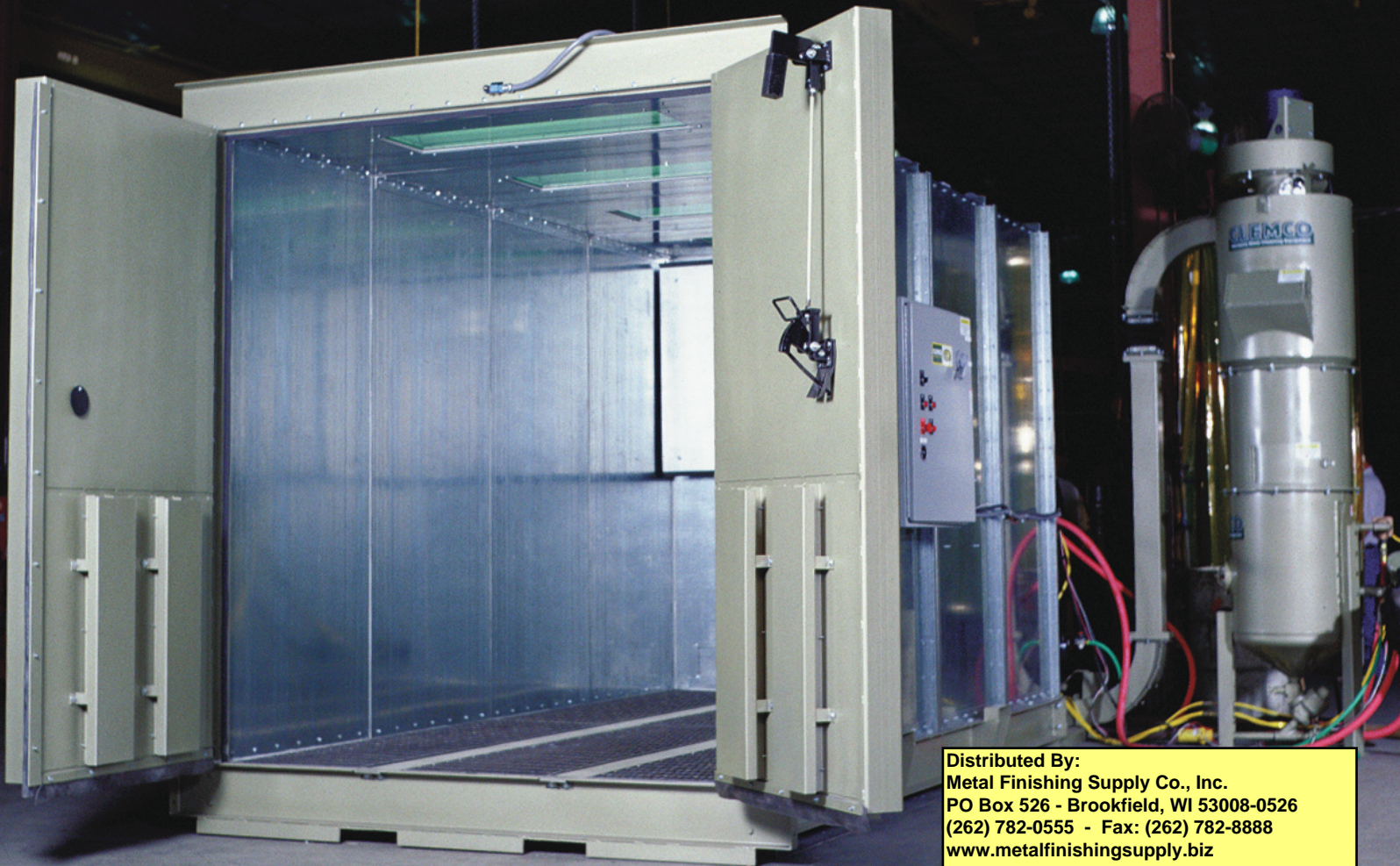

Distributed By:
Metal Finishing Supply Co., Inc.
PO Box 526 - Brookfield, WI 53008-0526
(262) 782-0555 - Fax: (262) 782-8888
www.metalfinishingupply.biz

INDUSTRIAL
Blast Facilities
by **CLEMCO**®

Pre-Assembled Blast Rooms

- ✓ No Pit Required
- ✓ Quickest Set-Up
- ✓ Lowest Total Cost for Complete System
- ✓ Enclosure, Blast Machine, Operator Safety Equipment, Recovery, Reclaimer, and Dust Collector
- ✓ Turnkey or Do-It-Yourself Installation
- ✓ An Industrial Blast Facility

The pre-assembled blast room is built on a rigid structural steel floor, with 10-gauge steel walls and 16-gauge steel ceiling, 1-1/2 inch thick floor grating, and full-height, full-width work doors.

High volume air inlets and a rugged down-flow dust collector combine to create true cross-draft ventilation at 50 fpm to minimize dust clouding inside. Bright fluorescent lighting enhances visibility.

Place the room on any smooth, level floor and install a ramp to minimize site-prep requirements, or install in a pit to make the blast room floor level with your existing floor.

Standard Systems Meet All Blasting Needs

Systems are available with mechanical recovery with air-wash abrasive cleaner, or pneumatic recovery with cyclone separator to let you tailor the pre-assembled room to your application. Standard systems are available for glass bead, harsh/aggressive media, light-weight, and heavy media.

For most recyclable media, from coarse ALOX to steel grit and shot, choose the Flat-Trak low-profile recovery floor coupled to a bucket elevator and air-wash abrasive cleaner. For fine glass bead and ALOX, or other light-weight media, the M-Section pneumatic recovery floor and cyclonic reclaimer work best.

The standard blast machine package includes a 6 cu. ft. blast machine, flexible Supa blast hose and carbide nozzle, pneumatic remote control system, and an Apollo 600 respirator with CPF air filter. Plastic media, wheat starch, or other lightweight media require a special blast machine with steep cone and accessories to enhance media flow. Special accessories are available to protect components from aggressive media like ALOX.

Dust Collection Designed for Abrasive Blasting

The Clemco Down-Flow dust collector ventilates the blast enclosure and powers the media cleaner. Reinforced pleated-fiber cartridges provide a 2.1-to-1 filter-to-air ratio, trapping particles as small as 0.5 micron. The filters are automatically pulsed clean with compressed air.

Directing exhaust air back into your building reduces heating and cooling costs. Optional HEPA filters virtually eliminate microscopic dust emissions.

Outstanding Distributor Support

The world-wide network of Clemco Distributors has more than 60 years of experience planning, installing, and maintaining industrial blast equipment. Your authorized Distributor has the trained personnel and a ready inventory of standard parts to keep your blast room operating at peak efficiency.

Distributed By:
Metal Finishing Supply Co., Inc.
PO Box 526 - Brookfield, WI 53008-0526
(262) 782-0555 - Fax: (262) 782-8888
www.metalfinishingsupply.biz

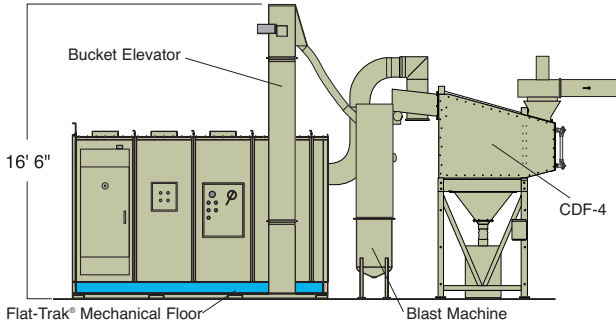
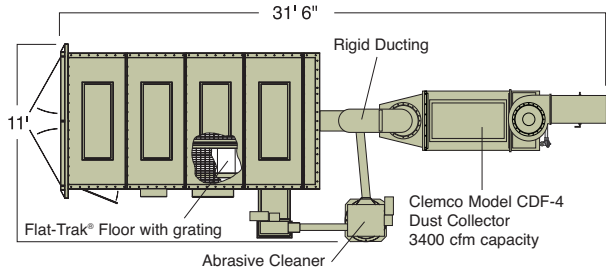

Flat-Trak® Pre-Assembled Blast Room

Recommended for most recyclable media.
Includes low-profile mechanical recovery floor, bucket elevator, and air-wash abrasive cleaner.

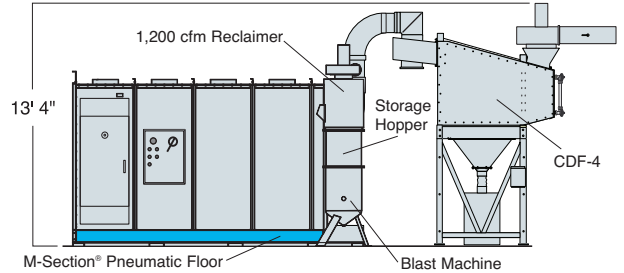
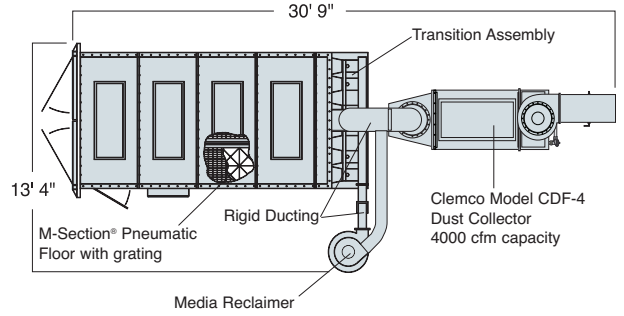

M-Section® Pre-Assembled Blast Room

Recommended for fine glass bead and ALOX, or other lightweight media. Includes pneumatic recovery floor, and cyclone media reclaimer.

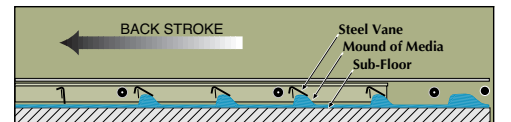
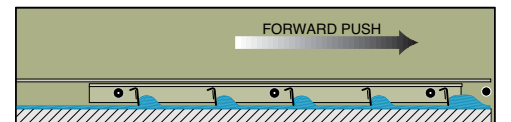
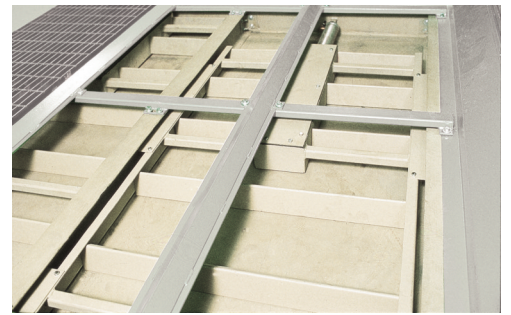

The Flat-Trak® Recovery Floor

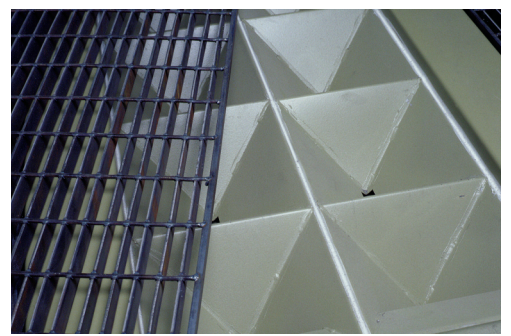
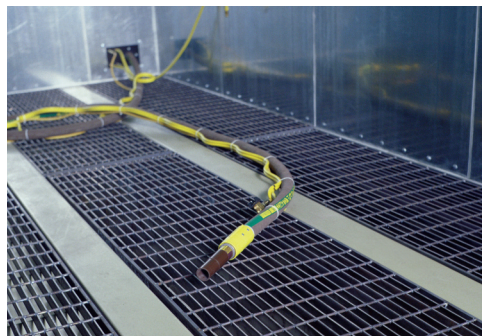

The M-Section® Recovery Floor

Typical M-Section® Pre-Assembled Blast Room

Includes pneumatic recovery floor, cyclone media reclaimer, down-flow dust collector, complete plan drawings, air and electrical specifications, and installation and startup instructions. *(Dust collector not shown)*

Distributed By:
Metal Finishing Supply Co., Inc.
PO Box 526 - Brookfield, WI 53008-0526
(262) 782-0555 - Fax: (262) 782-8888
www.metalfinishingsupply.biz

Specifications

Blast Room

Standard size - 14 ft long x 7 ft wide x 8 ft tall (interior dimensions)
(Other sizes by special order, but must meet federal DOT size limitations for transportation when assembled.)

Construction - 10-gauge steel walls, and 16-gauge steel ceiling and door panels.

Structural steel base supports recovery floor and standard 1-1/2" grating. Double doors swing open full width and full height for easy part loading. Large personnel door for ease of entry.

Safety Features

Apollo 600 respirator is NIOSH-approved and OSHA-certified to protect operator from lead dust concentrations up to 1000 times the permissible exposure limit. CPF filter removes moisture, oil and particles from breathing air.

Optional carbon monoxide monitor warns of dangerous CO levels.

Blast suit and gloves (included with the blast machine package) protect operator's hands and body from rebounding abrasive.

Remote control handle stops blasting automatically if operator drops blast hose.

Interlock system prevents blasting if any door is open. View ports allow monitoring of operator without interrupting blasting.

Red emergency stop button on control panel shuts down entire system.

Media Recovery

Flat-Trak® — Low-profile, full-area mechanical recovery is simple to operate and maintain. Grating: standard 1-1/2-inch thick for 250 lb./sq. ft. loading.

M-Section® — Full-area recovery with few moving parts to maintain. Optional rubber lining in transition elbow protects against wear. Grating: standard 1-1/2" thick for 2,000 lb./sq. ft. loading. Optional M-Section design for plastic media.

Down-Flow Dust Collector

Pleated filter cartridges are automatically pulse cleaned for efficiency and long life. Rigid ductwork connects blast room to dust collector. Flexible ductwork connects media separator to dust collector. Dust collector sized to suit application — 3,400 cfm for air-wash separator or 4,000 cfm for pneumatic recovery and cyclone separator.

Media Cleaning

Reclaimer: For lightweight and fine media — 1,200 cfm cyclone separator with rubber-lined inlet wear plate and 5-hp booster exhaust motor.

Air-wash abrasive cleaner: For heavy and coarse media — Two-stage cleaning with scalping drum and air-wash curtain. Includes bucket elevator.

Optional rubber-lined reclaimers, magnetic particle separators, dense particle separators, and multi-stage vibratory screen classification for applications that demand it.

Control Panel

Externally mounted panel with automatic start sequence and one-button shut down. For Flat-Trak® recovery floors, the panel allows precise control of recovery rates.

Standard wiring is 460 volts, 3-phase, 60 hertz, with transformer for step down voltage. Wiring and conduits between components must be supplied by customer to meet local electrical code.

Blast Machine Package

6 cubic foot capacity, 150-psi rated, ASME-code pressure vessel with 1-1/4-inch piping and 1-1/2-inch moisture separator with automatic drain. Includes Supa blast hose, pneumatic remote controls, 3/8 -inch orifice carbide venturi nozzle and all couplings, gaskets, and locking pins.

Installation and Startup

Pre-assembled blast room systems include complete plan drawings, air and electrical specifications, installation instructions and one-day start-up supervision for operational and maintenance training. Most customers, with advice from their Clemco distributor, have the resources and personnel needed to install the complete system. As an option, Clemco can provide turnkey installation.

Accessories

Work car, tracks & turntable • External operator station • HEPA Filter • Dust collector explosion vent panels
Aggressive Media Options: Wear curtains • Boron carbide nozzles • Reclaimer and transition rubber lining



Distributed by:

Distributed By:
Metal Finishing Supply Co., Inc.
PO Box 526 - Brookfield, WI 53008-0526
(262) 782-0555 - Fax: (262) 782-8888
www.metalfinishingsupply.biz

ISO 9001:2008 certified. Clemco is committed to continuous product improvement. Specifications are subject to change without notice.

© 2012 Clemco Industries Corp. • Washington, MO 63090 • 636 239-0300 • FAX 800 726-7559

Stock No. 22345

info@clemcoindustries.com • www.clemcoindustries.com

1297 Rev. D, 11/12